

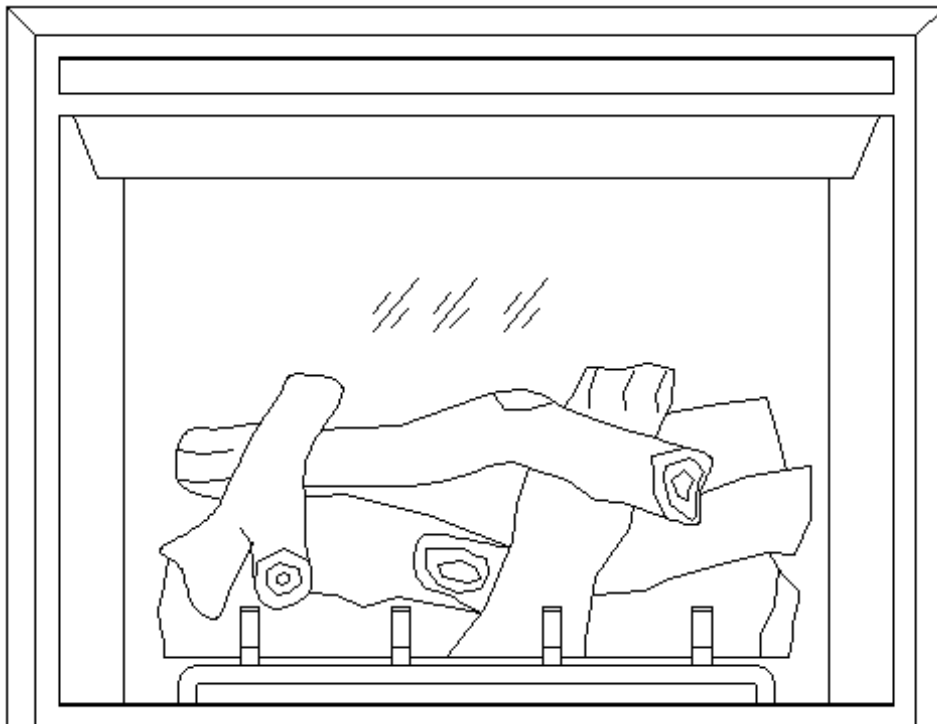

# ELECTRIC FIREPLACE INSERT

Model No.: WESTERN (EF42D-45D)

## OWNER'S MANUAL



### **WARNING**

**Read and understand** this entire owner's manual, including **all safety information**, before plugging in or **using** this product. Failure to do so could result in **fire, electric shock, or serious personal injury**.

### **CAUTION**

**Keep this owner's manual** for future reference. If you sell or give this product away, **make sure this manual accompanies this product**.

**NO VENTING REQUIRED**  
**120V AC; 60 Hz; 1500 Watts**

# CONTENTS

- Important Safety Information ..... 3**
- Preparation ..... 5**
- Product Dimension ..... 6**
- Assembly ..... 7**
- Battery Information ..... 7**
- Operation ..... 8**
  - Control Panel ..... 9**
  - Remote Control ..... 10**
- Care and Maintenance ..... 11**
- Schematic Diagram ..... 12**
- FAQ – Frequently Asked Questions ..... 13**
- Troubleshooting Guide ..... 14**
- Limited Warranty ..... 15**
- Customer Service ..... 15**

# IMPORTANT SAFETY INFORMATION!

## WARNING

- **Read all instructions before using this heater!**
- This heater is **hot when in use**. To avoid burns, **DO NOT** let bare skin touch **hot** surfaces. If provided, use handles when moving this heater. Keep **combustible materials**, such as furniture, pillows, bedding, papers, clothes, and curtains at least **3 feet (0.9m)** from the **front of the heater**, and **keep them away from the sides and rear**.
- **Extreme caution** is necessary when any heater is used by or near **children** or **invalids** and whenever the heater is left **operating and unattended**.
- **DO NOT** operate any heater with a **damaged cord or plug** or after the **heater malfunctions**, has been **dropped** or **damaged in any manner**. Discard heater, or return to authorized service facility for examination and/or repair.
- **DO NOT** run **power cord** under carpeting. **DO NOT** cover power cord with throw rugs, runners, or similar coverings. **DO NOT** route power cord under furniture or appliances. Arrange power cord **away from traffic** area, and where it will not be tripped over.
- **DO NOT** insert or allow **foreign objects** to enter any **ventilation or exhaust opening**, as this may cause **electric shock** or **fire**, or **damage the heater**.
- To prevent a possible fire, **DO NOT** block air intakes or exhaust in any manner. Doing so could cause a **fire**. **DO NOT** use on soft surfaces, like a bed, where openings may become blocked.
- A heater has **hot and arcing or sparking parts inside**. **DO NOT** use it in areas where **gasoline, paint, or flammable liquids** are used or stored.
- **Use this heater only as described in this manual. Any other use not recommended by the manufacturer may cause fire, electric shock, or injury to persons.**
- **ALWAYS** plug heaters directly into a wall outlet/receptacle. **NEVER** use with an extension cord or relocatable power tap (outlet/power strip).
- **Connect to properly grounded outlets ONLY.**
- **DO NOT** place the heater near a bed because objects such as pillows or blankets can fall off the bed and be ignited by the heater.
- **NEVER** use this heater in **bathrooms, laundry rooms**, or any other location where the heater could fall into a **bathtub** or **pool**, become **damp**, or **come in contact with water**.
- **AVOID FIRE!** Regularly inspect all air vents to make sure they are free from dust, lint, or other blockage. **Unplug the unit** and clean with a **vacuum ONLY**. **DO NOT** rinse or get wet.
- **NEVER** permanently install in a **recessed area of the wall**. This may result in **blocked air flow, overheating, or fire**.
- **WARNING: DO NOT DEPEND ON THE POWER SWITCH THE SOLE MEANS OF DISCONNECTING POWER WHEN SERVICING OR MOVING THE HEATER. ALWAYS UNPLUG THE POWER CORD.**
- **WARNING: REDUCE THE RISK OF FIRE OR ELECTRIC SHOCK---DO NOT USE THIS HEATER WITH ANY SOLID STATE SPEED CONTROL DEVICES.**
- **For residential use only! NOT for commercial use!** Any commercial or public use of this

heater **voids all warranties**, and could cause **injury**.

- This product is **not intended** to be a **primary heat source**. It is for **supplemental heat only**.
- **INDOOR use only! NEVER** use this heater **outdoors!** Doing so may result in **electric shock!**
- **Risk of electric shock! DO NOT OPEN!** No user-serviceable parts inside!
- **NEVER modify this heater.** Doing so could result in personal **injury** or property **damage**. Modification of this fireplace **completely voids all warranties**.
- **ALWAYS** turn this heater off before unplugging it from the outlet.
- **ALWAYS disconnect** this unit from the **power** supply **before** performing any assembly or cleaning, or before relocating the electric fireplace.
- **NEVER** leave this heater unattended. **ALWAYS** unplug this heater when not in use.
- **ALWAYS** store this heater in a dry location. **NEVER** use the fireplace if it has become wet.
- **ONLY** use this heater on a **120V AC 15-Amp circuit**. **NEVER overload the circuit**. If this heater trips the circuit breaker, unplug all other appliances on the same circuit before the next use. Avoid plugging other appliances into the same circuit as this heater.
- **NEVER** plug this heater into an outlet that is **old, cracked,** or has any **loose wires or connections**. Plugging this heater into a faulty outlet could result in **electric arcing** within the outlet that could cause the **outlet to overheat or catch fire**.
- **ALWAYS** check your heater cord and plug connections with **each use!**
  - i) **MAKE SURE** the plug fits tight in the outlet! Faulty wall outlet connections or loose plugs can cause the outlet to overheat.
  - ii) **Heaters draw more current** than small appliances. **Overheating** may occur even if it has not occurred with the use of other appliances.
  - iii) During use **check frequently** to see if the **plug outlet or faceplate is HOT!**
  - iv) If the outlet or faceplate is **HOT, discontinue use immediately** and have a qualified electrician inspect and/or replace the faulty outlets.
- This heater has a **polarized plug (one blade is wider than the other)**. As a safety feature to reduce the risk of electrical shock, this plug is intended to fit in a polarized outlet only one way. If the plug does not fit fully in the outlet, reverse the plug. If it still does not fit, contact a qualified electrician. Do not attempt to defeat this safety feature.
- **SAVE THESE INSTRUCTIONS!**

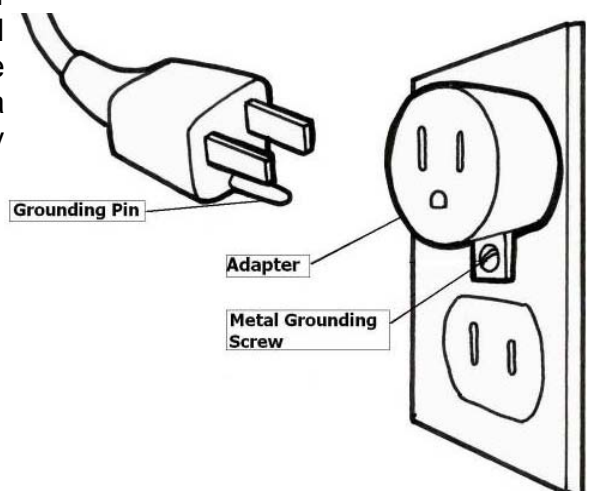

# PREPARATION



**DO NOT** use this Electric Fireplace if any part has been **under water**. Immediately call a qualified **service technician** to inspect and to replace any part of the electrical system if necessary. Keep **plastic** wrapping away from **children**.

Unpacking the Electric Fireplace. Remove all parts and hardware from the carton and place them on a clean, soft, dry surface. Check the parts list to make sure nothing is missing. Dispose of packaging materials properly. Please recycle whenever possible. Keep the original packaging for future transport and/or storage.

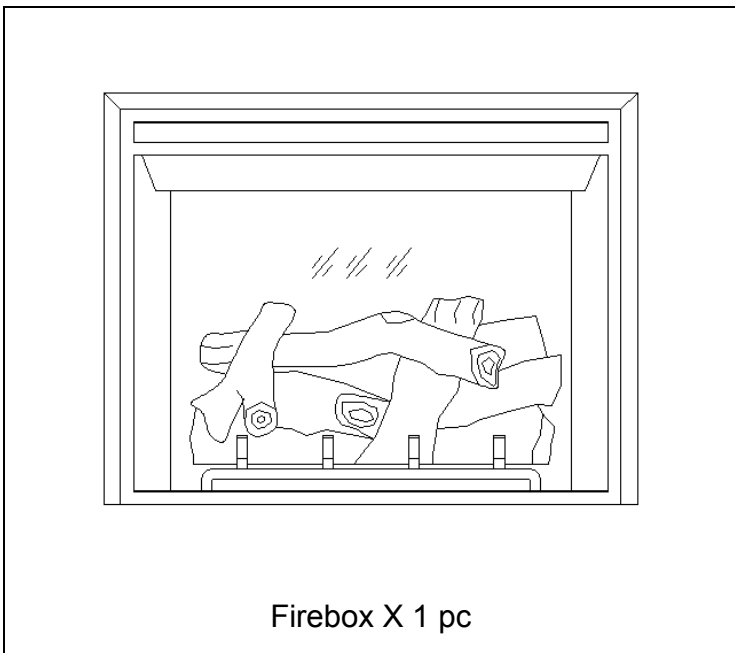

Firebox X 1 pc

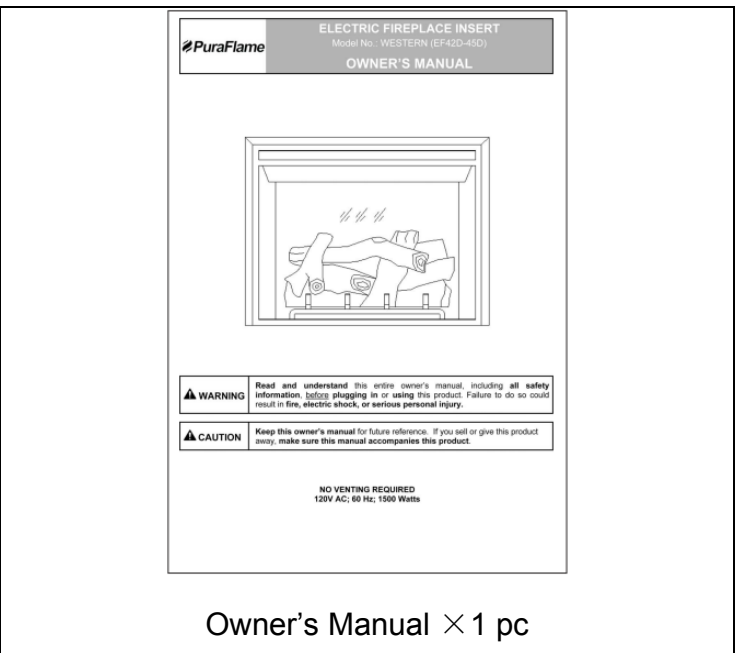

Owner's Manual × 1 pc

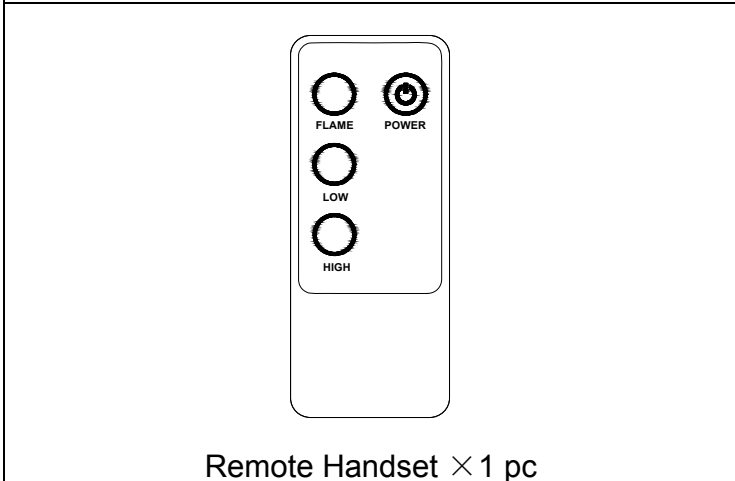

Remote Handset × 1 pc

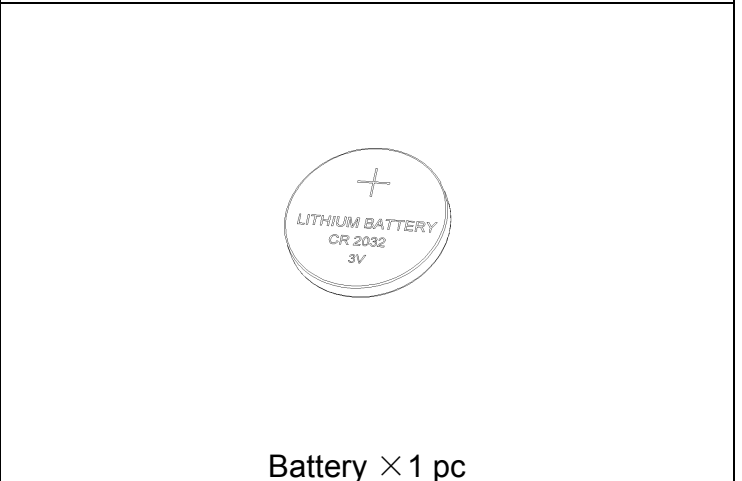

Battery × 1 pc

# PRODUCT DIMENSIONS

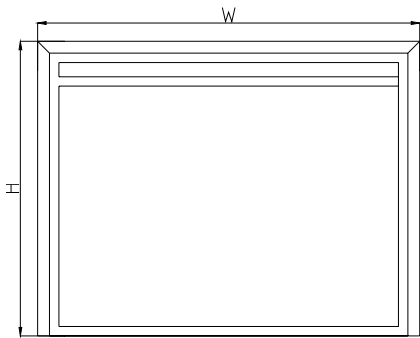

Fireplace Insert

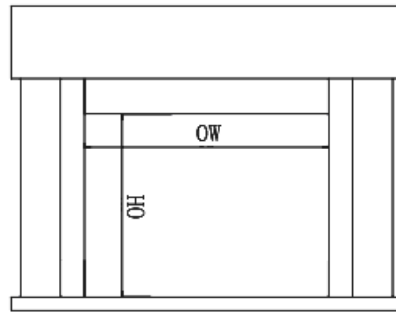
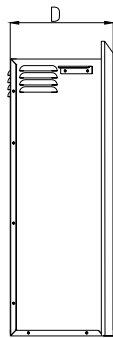

Fireplace Mantel

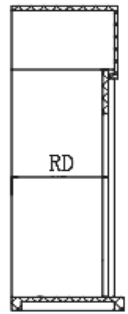

Units:mm

Model	Width (W)	Height (H)	Depth (D)	Mantel opening size		Mantel Minimum Depth (RD)
				Width (OW)	Height (OH)	
EF42D	630	545	220	580-610	510-540	205
EF43D	710	625	220	660-690	590-620	205
EF44D	810	625	220	760-790	590-620	205
EF45D	890	685	220	840-870	650-680	205

Units:inch

Model	Width (W)	Height (H)	Depth (D)	Mantel opening size		Mantel Minimum Depth (RD)
				Width (OW)	Height (OH)	
EF42D	24.8	21.5	8.7	22.8-24	20.1-21.3	8.1
EF43D	28	24.6	8.7	26-27.2	23.2-24.4	8.1
EF44D	31.9	24.6	8.7	30-31.1	23.2-24.4	8.1
EF45D	35	27	8.7	33.1-34.3	25.6-26.8	8.1

## ASSEMBLY



**ALWAYS unplug** this fireplace heater **before assembly** or **cleaning**, or **before relocating**. Failure to do so could result in **electric shock**, **fire**, or **personal injury**.

**KEEP drapery and other furnishings** at least **3ft /0.9m** from the **front** and **sides** of the electric fireplace.

**AFTER installation**, ensure that there is **≥0.004 m<sup>2</sup> ventilation area** between **inside** and **outside** of fireplace mantel.

Your new electric fireplace may be installed virtually anywhere in your home. However, when choosing a location ensure that the general instructions are followed. For best results, install out of direct sunlight. Power supply service must be either completed or placed within the electric fireplace prior to finishing to avoid reconstruction.

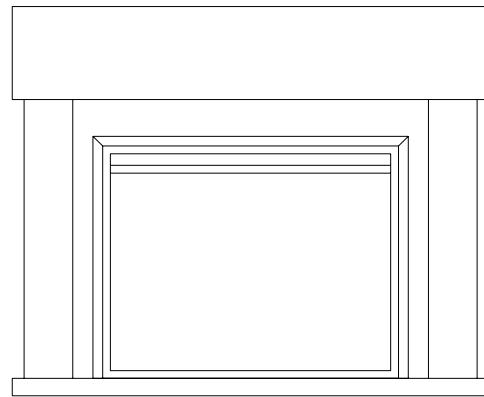
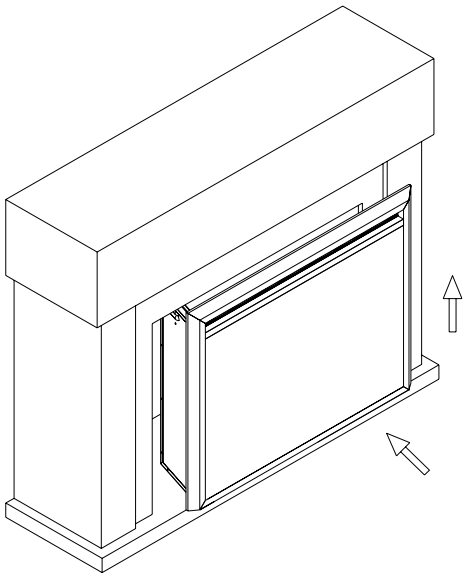

When moving the insert into mantel, Do not let bottom of insert touch the mantel to avoid the scratch.

## BATTERY INFORMATION

- This remote control uses **one CR2032 Lithium Ion button cell battery** (included).
- Instructions for battery installation are inside the Remote Control battery compartment.
- Always replace the battery in the remote control with the same type of battery.



**NEVER** dispose of batteries in **fire**. Failure to observe this precaution **may result in an explosion**. Dispose of batteries at your local hazardous material processing center, or as required by local ordinances.

# OPERATION



Read and understand this entire owner's manual, including **all safety information**, before plugging in or using this product. Failure to do so could result in **electric shock, fire, serious injury, or death.**

## Power

Make sure the Power Switch, located on the control panel, is in the OFF position. Plug the power cord into a 110~120 Volt 15 Amp outlet (see **IMPORTANT SAFETY INFORMATION** on **Pages 3 and 4**). Make sure the outlet is in good condition and that the plug is not loose. **NEVER** exceed the maximum amperage for the circuit. **DO NOT** plug other appliances into the same circuit.

## Temperature Limiting Control

This heater is equipped with a Temperature Limiting Control. Should the heater reach an unsafe temperature, the heater will automatically turn OFF. To reset:

1. Unplug the power cord from the outlet.
2. Turn the Power Switch on the CONTROL PANEL to OFF. **Wait at least 5 minutes.**
3. Inspect the fireplace to make sure no vents are blocked, or clogged with dust or lint. If they are, use a vacuum to clean the vent areas.
4. With the Power Switch in the OFF position, plug the power cord back into the outlet.
5. If it switches off again, **UNPLUG THE HEATER RIGHT AWAY!** Have the outlets, wiring, and breaker box inspected by a professional. Make necessary repairs before using the heater.

## Heater Rating

Maximum heat output: 1500W (4600BTU); Maximum heating area: 400 square feet.

## Operation

Review the **IMPORTANT SAFETY INFORMATION** on **Pages 3 and 4** before operating.

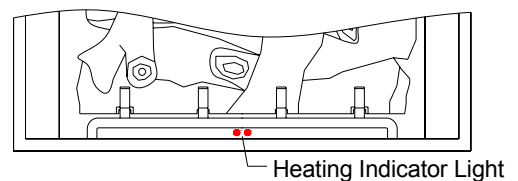
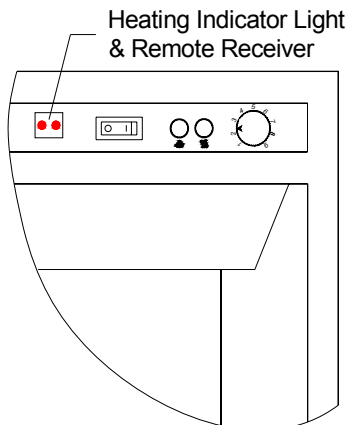

**NOTICE:** When the heater is first turned on, a slight odor may be present. This is normal and should not occur again unless the heater is not used for a long period of time.





## Control Panel



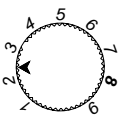

Located on the right and top side panel of the fireplace.

BUTTON	NAME	FUNCTION
	<b>POWER SWITCH</b>	Turn on the main power supply. A long “beep” sound will be heard when the switch is turned on On Position “1”.  <b>Note:</b> The remote control will lost the memory for function settings when the switch is turned on Off Position “0”.
	<b>FLAME</b>	The flame will be cycled Flame A – Flame B – Flame C – Flame Off.  Flame A: full bright flame + little blue Flame B: full bright flame Flame C: half bright flame
	<b>HEATER</b>	The heater will be cycled Low – High – Heater Off. You will see the indicator light illuminates on left to Power Switch. The indicator light goes out within 10s.  Low: (●○) High: (●●)  <b>Note:</b> 1. Heater can be used without flame. 2. Whether the heating is working depends on whether the settled temperature by thermostat is higher than the environment temperature. 3. The Fan works anterior to the heater about 10s, and turns off later than the heater about 10s. 4. The indicator light in the lower fuel bed always illuminates when heater is on.
	<b>THERMOSTAT</b>	Start with setting 9 and when the room has reached a desired level, turn the rotary switch counterclockwise until the thermostat just ‘clicks’ off. The thermostat will then maintain the room at the selected level. To increase the temperature, turn the rotary switch clockwise to a higher setting.

## Remote Control

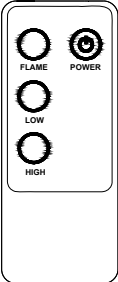
Control panel Power Switch must be ON to use remote control.

**NOTICE:** Aim the remote control at the **remote receiver**. Make sure you **hear a beep each time you press the button!** If not, the fireplace **will not respond** to the signal.

REMOTE	BUTTON	NAME	FUNCTION
	 POWER	POWER	This fireplace can be easily operated by this button. All function settings will be memorized if the fireplace is turned off by "Power Button". For next use, we can only push this button to have the same settings (can both for flame and heater) as latest use. For first time use, it will turn on Flame A.
	 FLAME	FLAME	The flame will be cycled Flame A – Flame B – Flame C – Flame Off.
	 LOW	LOW HEAT	To turn on the heater on half heat setting or turn off the heater.
	 HIGH	HIGH HEAT	To turn on the heater on full heat setting or turn off the heater.

## CARE AND MAINTENANCE



**ALWAYS** turn the heater **OFF** and **unplug the power cord from the outlet** before cleaning, performing maintenance, or moving this fireplace. Failure to do so could result in **electric shock, fire, or personal injury**.

### Cleaning



**NEVER** immerse in water or **spray with water**. Doing so could result in **electric shock, fire, or personal injury**.

#### **Metal:**

- Buff using a soft cloth, slightly dampened with a citrus oil-based product.
- **DO NOT** use brass polish or household cleaners as these products will damage the metal trim.

#### **Glass:**

- Use a good quality glass cleaner and dry thoroughly with a paper towel or lint-free cloth.
- **NEVER** use abrasive cleansers, liquid sprays, or any cleaner that could scratch the surface.

#### **Plastic:**

- Wipe gently with a slightly damp cloth and a mild solution of dish soap and warm water.
- **NEVER** use abrasive cleansers, liquid sprays, or any cleaner that could scratch the surface.

#### **Vents:**

- Use a vacuum or duster to remove dust and dirt from the heater and vent areas.
- Clean the exterior of the fireplace with a slightly damp cloth or duster.

### Maintenance



**Risk of electric shock! DO NOT OPEN! No user-serviceable parts inside!**



**ALWAYS** turn the heater **OFF** and **unplug the power cord from the outlet** before cleaning, performing maintenance, or moving this fireplace. Failure to do so could result in **electric shock, fire, or personal injury**.

#### **Electrical and Moving Parts:**

- The fan motors are lubricated at the factory and will not require lubrication.
- Electrical components are integrated in the fireplace and are not serviceable by the consumer.

#### **Storage:**

- Store heater in a clean dry place when not in use.

#### **Replacement parts:**

- Use only replacement parts supplied by the manufacturer. Use of any other parts, or modifying the fireplace in any way, will void all warranties.
- No internal parts are replaceable or serviceable.



**WARNING!** No other servicing should be performed by the consumer. Do not attempt to service the unit yourself

# SCHEMATIC DIAGRAM

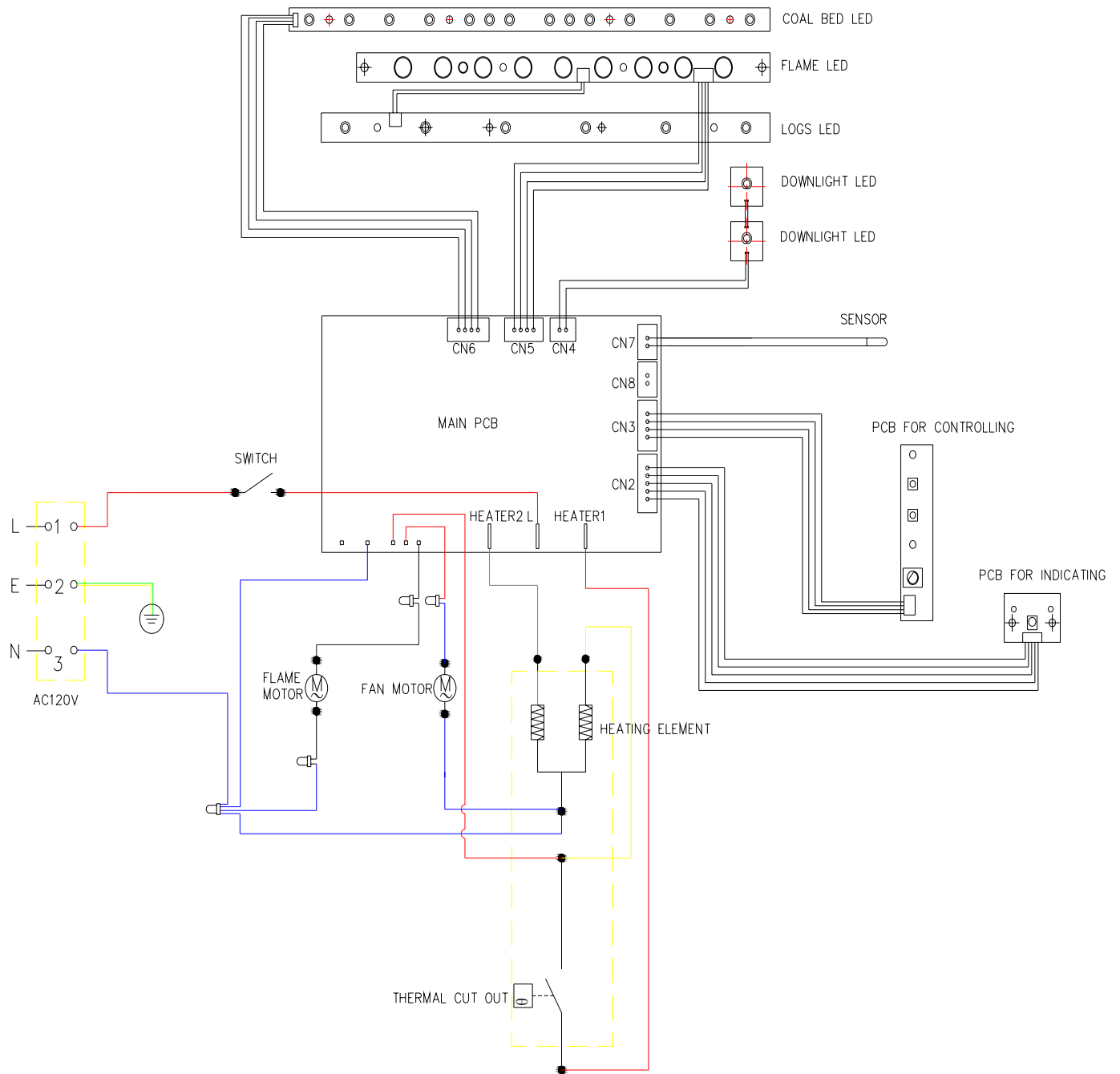

## FAQ - FREQUENTLY ASKED QUESTIONS

- **Why does the fan blow before the heat comes on, and after the heater is turned off?**  
Heat and cool gradually. The fan blows when the heater is first turned on, and the heat is still heating up. After the heater turns off, the fan will continue to blow air for 10 seconds. This allows the fireplace to cool slowly, and helps prevent overheating.
- **What does the fireplace beep? Can I turn the beeping off?**  
The beeps indicate that the signal from the control panel, or remote control, has been received by the fireplace. The beeping cannot be turned off.
- **Why doesn't the fireplace function change when remote control setting changes?**  
The fireplace function will only change if there is a beep after pressing the button. If you do not hear a beep, try again. If you hear a beep, the fireplace function will change to match the remote control setting.
- **Why does the remote control not work, or only work sometimes?**  
Check to make sure the batteries are good. If necessary, change to new batteries. If the remote control is not aimed properly, if you are too far away, or if you are too far off to the side, the signal may not reach the fireplace. Get closer, aim at the upper top corner of the screen (where the red heat indicator light is located), and try again.
- **How do I change from high heat to low heater?**  
The heater is controlled by the heater button on the control panel, or the heater buttons on the remote control.
- **Is the thermostat setting accurate?**  
The temperature within a room can vary. Room size, fireplace location, air flow, sunlight, wall type (interior vs. exterior), insulation, etc. all affect temperature. The fireplace setting may not match your home thermostat exactly. This is normal. Try different thermostat setting on your fireplace until you find one that is right for you.
- **Can I use heater without flame effect?**  
The heater can be used without flame effect. But the indicator light on the lower fuel bed always illuminates when heating on.

## TROUBLESHOOTING GUIDE

PROBLEM	SOLUTION
There is no <b>power</b> to the fireplace, or it does not turn on.	<ol style="list-style-type: none"> <li>1. Make sure the power cord is plugged into a functioning and properly grounded 15 Amp 120V AC electrical outlet.</li> <li>2. Make sure the Power Switch on the control panel is ON.</li> <li>3. If the unit had been working, but then turned off by itself, the temperature limiting control may need to be reset. See page <b>8</b> for instructions.</li> <li>4. Check for damage to the power cord or plug. If damaged, <b>DO NOT USE.</b></li> </ol>
The <b>control panel functions</b> do not work.	<ol style="list-style-type: none"> <li>1. Make sure the Power Switch on the control panel is turned on. If it is OFF, the functions will not work.</li> <li>2. If the Power Switch is ON, and the functions do not work, please e-mail us at <b>customerservice@puraflame.com</b></li> </ol>
The <b>FLAME button</b> doesn't work.	<ol style="list-style-type: none"> <li>1. Make sure the Power Switch on the control panel is ON.</li> <li>2. If the Power Switch is ON, and the functions do not work, please e-mail us at <b>customerservice@puraflame.com</b></li> </ol>
The <b>heater</b> does not work.	<ol style="list-style-type: none"> <li>1. Make sure the Power Switch on the control panel turned on.</li> <li>2. Control Panel: Press the heater button on the control panel to override the thermostat at any time.</li> <li>3. Remote control: Make sure the thermostat is not set too low. If the thermostat is set lower than room temperature, the heater will not turn on.</li> <li>4. If none of these solutions work, please e-mail us at <b>customerservice@puraflame.com</b></li> </ol>
The <b>heater</b> does not blow <b>hot air</b> when it turns on and off.	This is normal. The fans blow cool air while the heater gradually heat up. The fans blow after the heater turn off to cool the heater and prevent overheating.
The <b>remote control</b> does not work.	<ol style="list-style-type: none"> <li>1. Make sure the battery is properly installed.</li> <li>2. Make sure the Power Switch on the control panel is turned on. <b>The remote control will not work unless the POWER SWITCH on the control panel is turned on.</b></li> <li>3. Aim the remote control at the receiver.</li> <li>4. Remove objects that may be in the way. Items between the remote control and the remote control receiver will block the signal.</li> <li>5. Don't press the remote control buttons too quickly. Give the unit time to respond to your commands.</li> </ol>
The <b>thermostat</b> does not work.	<ol style="list-style-type: none"> <li>1. Make sure the heater is turned on. <b>The thermostat will not work unless the heater is turned on.</b></li> <li>2. Make sure the thermostat is not set too low. If the thermostat is set lower than room temperature, the heater will turn on.</li> </ol>

## LIMITED WARRANTY

This warrants to the original purchaser that this product is free from defects in material and workmanship as of the date of purchase and that it will, under normal use and proper care, remain so for one year from the date of purchase. Missing or initially defective parts will be replaced free of charge during the period of this limited warranty. If parts are unavailable, comparable replacement or refund will be given. **The original dated sales receipt is required for all warranty claims.** This warranty does not cover damage which has occurred during transport from the point of purchase to the consumer's home. This warranty does not cover glass, light bulbs, batteries, transportation, labor, or other issues not associated with the manufacture of the product.

**This product is for residential use only. Any and all commercial use of this product voids all warranties, and frees the manufacturer from all liability.**

Read and understand all assembly and operating instructions, and all safety information and warnings, before use. The following will void this warranty: Damage caused from tampering with, modifying, or altering the fireplace insert in any manner; Damage due to incorrect assembly, improper care, misuse, or abuse; Damage from being used with the wrong power source; Water damage; Damage caused from this insert being used outdoors; Damage caused from this insert being used for excessive periods of time; Damage caused by the insert being used in a commercial application; Damage from use as a primary heat source; Other misuse or abuse not specifically listed herein.

**This product is not intended to be used as a primary heat source. It is for supplemental heating purposes only.**

Thank you for purchasing this product! If you have questions about assembly or operation of this product, are missing parts, or if the product is damaged, please e-mail us at:

**[customerservice@puraflame.com](mailto:customerservice@puraflame.com)**



